



## Perspektive der Umweltverbände

---

Andreas Knutti  
Tagung Einzugsgebietsmanagement  
Fribourg, 23. Mai 2011

---



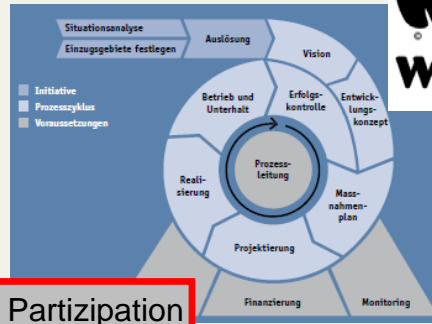

Partizipation

Gemeinsam  
bereits  
Ziele definieren

Perspektive der Umweltverbände

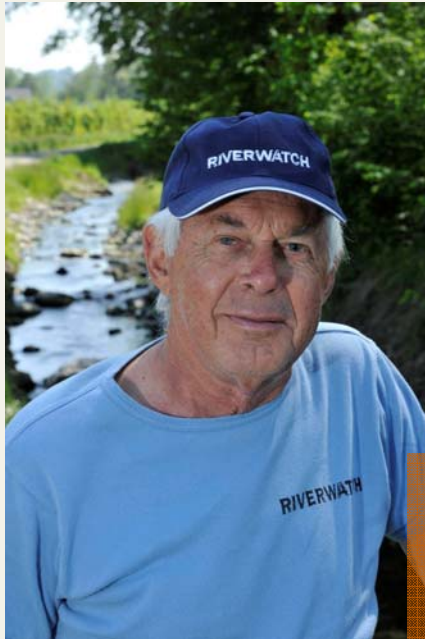

- Initiative
- Zusammenarbeit
- Netzwerk

Perspektive der Umweltverbände

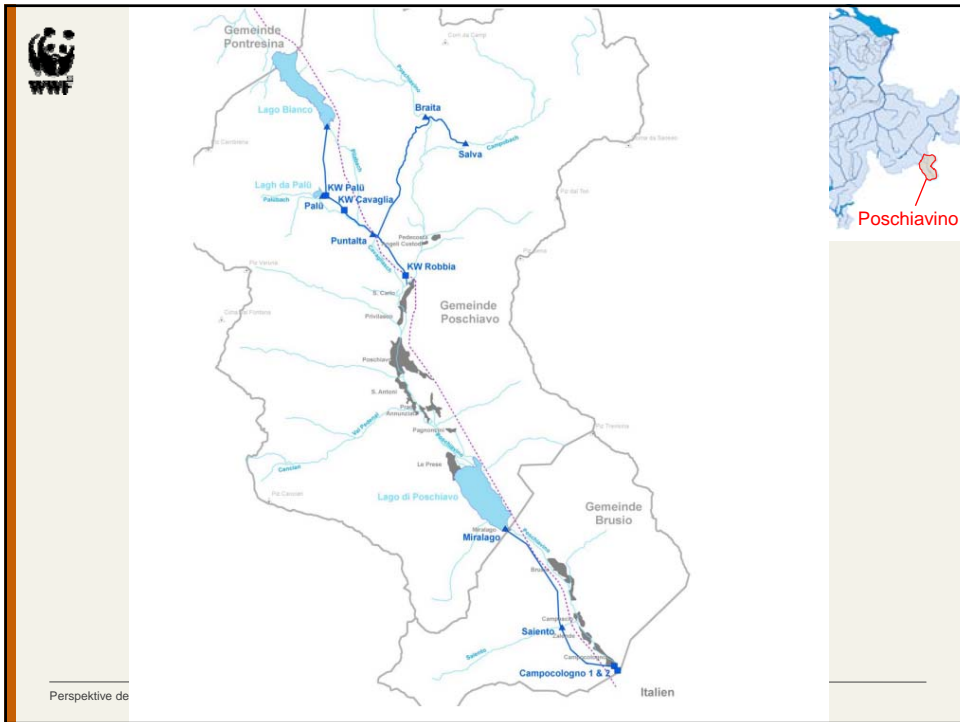
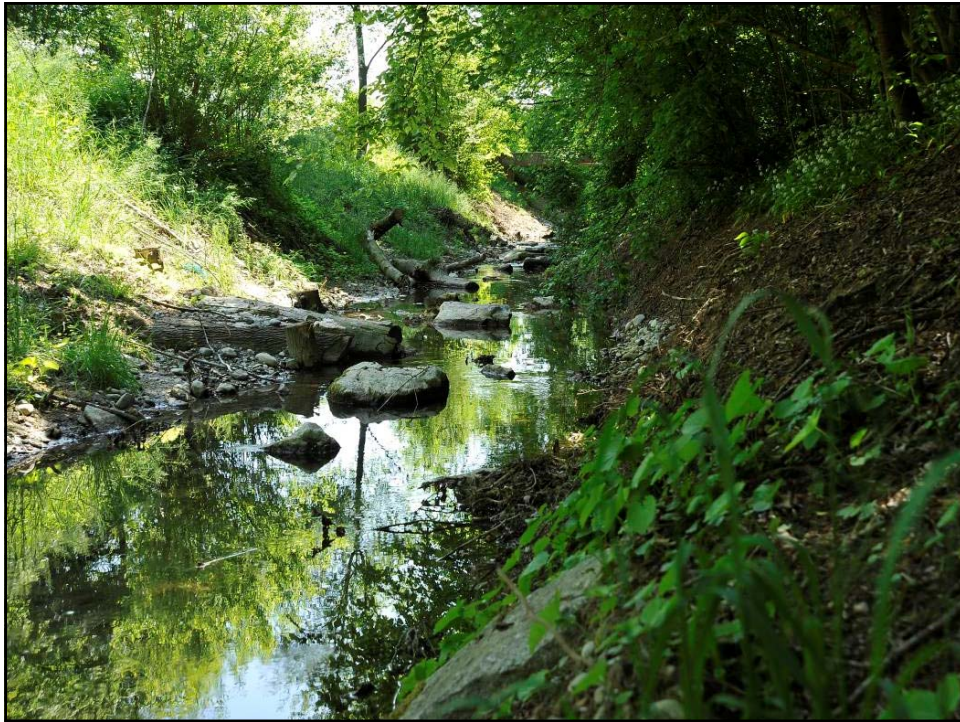

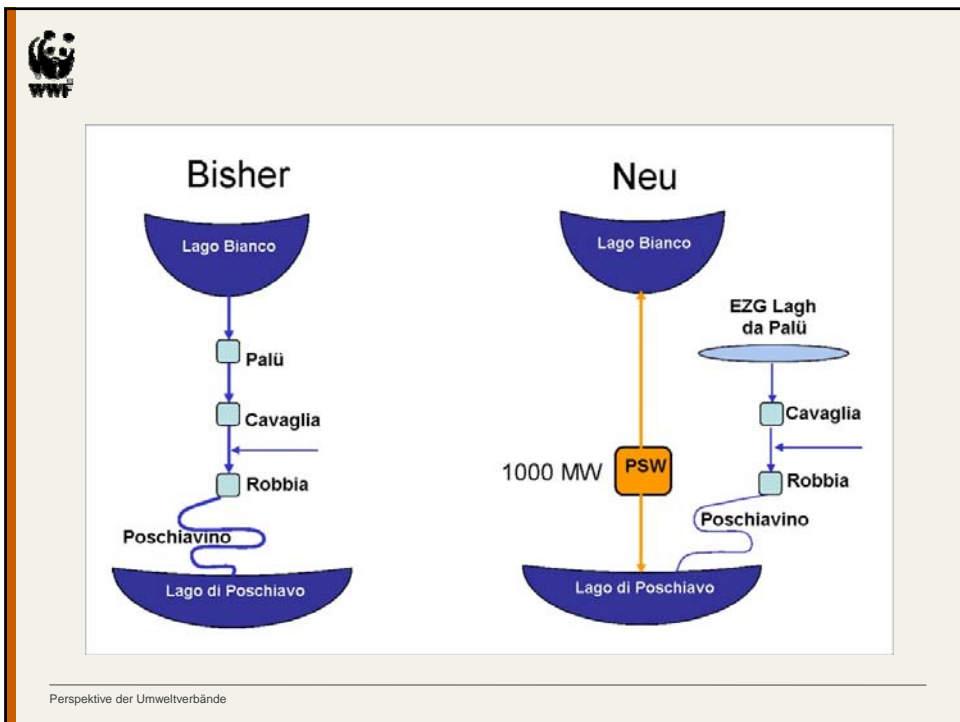
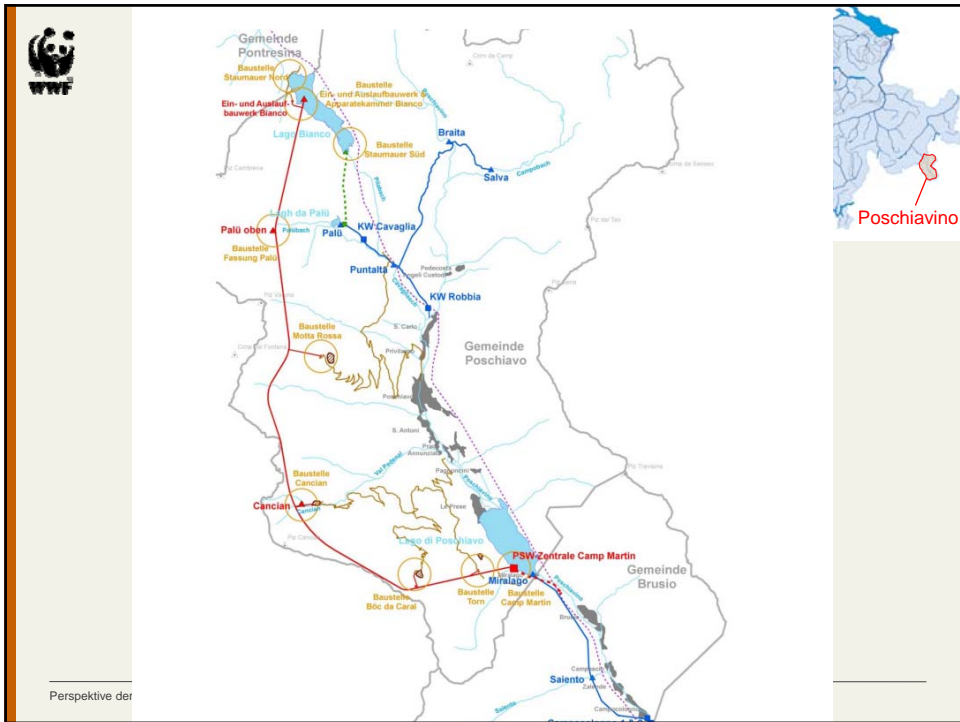

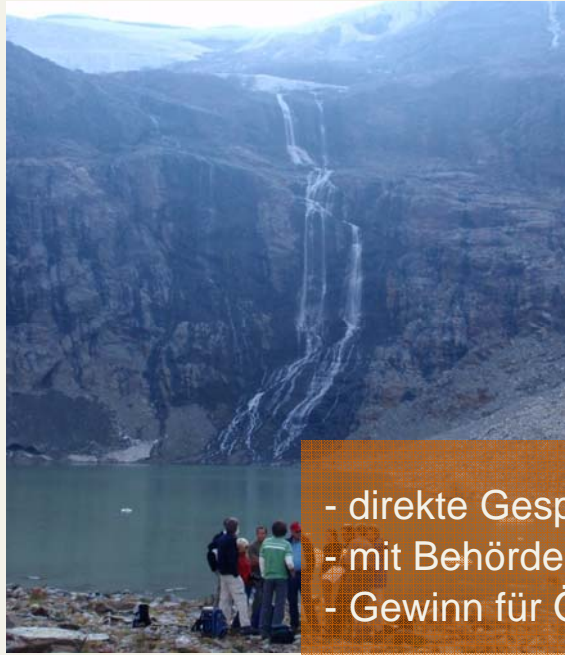

- direkte Gespräche
- mit Behörden
- Gewinn für Ökologie

Perspektive der Umweltverbände

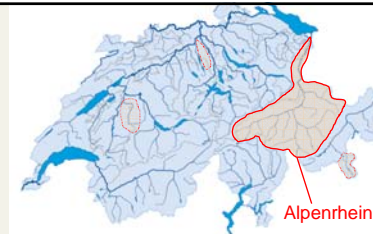

Perspektive der Umweltverbände

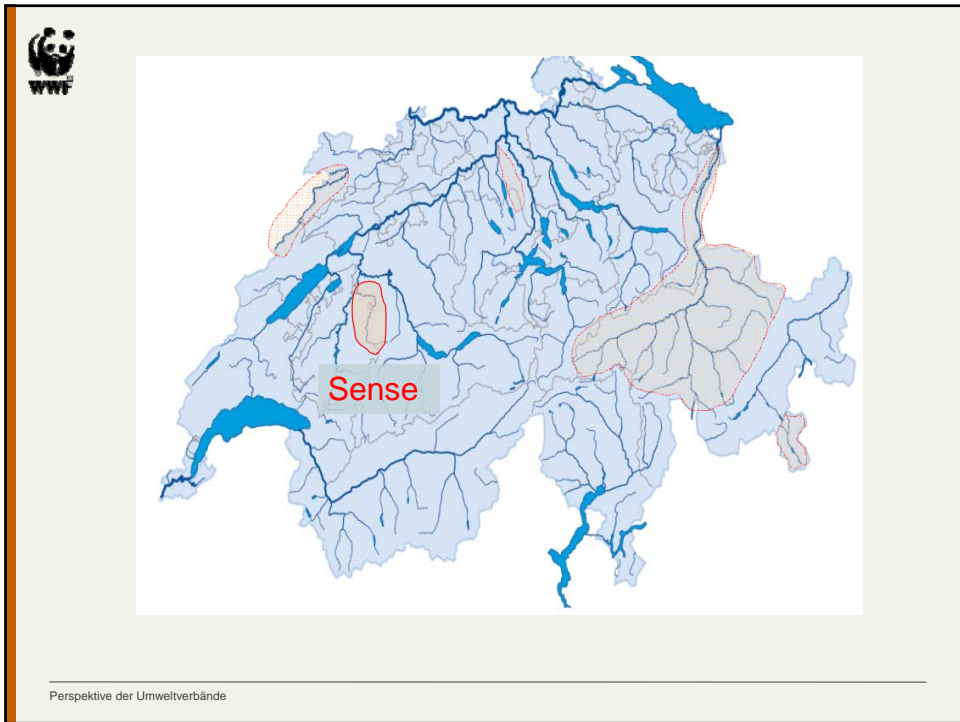



Sense: Schützen  
und aufwerten!

Perspektive der Umweltverbände



### Zutaten Erfolgsrezept

- Frühzeitige Mitwirkung
- Miteinander reden
- Wasserkraft nicht um jeden Preis

Perspektive der Umweltverbände



Merci!



[www.wwf.ch](http://www.wwf.ch)

Perspektive der Umweltverbände





## Zunahme der Produktion durch Neubau und Umbau von Wasserkraftwerken

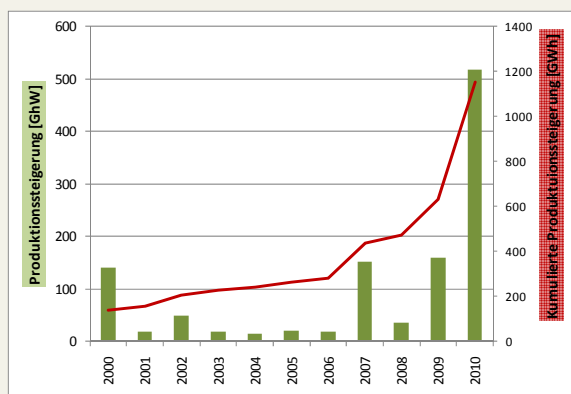

**+1151**  
GWh  
Steigerung der mittleren  
Produktionserwartung  
seit 2000

Zusätzlich 250  
GWh im Bau



Anlagen:	332	233	122	<del>143</del>
Produktion [GWh]:	269	736	465	<del>875</del>

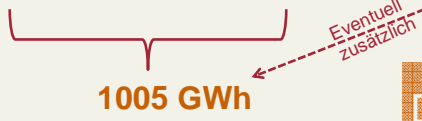

Das Energieziel für Kleinwasserkraftwerke bis 2030 kann erreicht werden.

